



ISO9001国际质量体系认证企业

中国船舶设备网、中国冶金设备网会员单位

中国钢铁工业协会冶金设备配件服务中心成员单位



Jiangsu Susen Clamps Manufacturing Co., Ltd.

**液压管道附件**

产品手册  
Products Manual

Hydraulic Pipeline Accessories

江苏苏鑫管夹制造有限公司

# 企业简介

## Company Profile



**江**苏苏鑫管夹制造有限公司位于江苏省阜宁县经济开发区。是专业从事液压管道附件研发、生产的企业，已有 18 年的管夹制造经验。公司主要生产全系列塑料管夹、铝合金管夹、钢制管夹、船用管夹、U 型管夹、高压液压球阀、高压液压截止阀等 24 个系列 6800 种产品。产品符合国际标准和国家重型机械标准。长期以来为冶金、船舶、海洋工程、重型机械、工程机械、机床、电力、造纸、液压系统等提供优质配套产品，深受客户欢迎。

在所有工业化的城市里，苏鑫管夹象征着管子和软管的快速安装以及清楚分明的管道布局，减振和降噪特性因对环境保护的重要贡献而受到重视。苏鑫管夹也是液压管道安装上最经济的产品之一。苏鑫管夹的应用场合几乎是无限的，因其广阔的产品范围，几乎涵盖了全部领域的管子和软管的安装和固定。

苏鑫管夹在国内长期为首都钢铁、柳州钢铁、南京钢铁、宝钢、太原钢铁、马鞍山钢铁、中国一重、二重等国内大型钢铁企业和众多船舶制造、海洋工程、重型机械、液压机械、润滑、造纸等行业提供大量配套产品。苏鑫管夹的产品已成功进入国际市场，在国际上已与众多知名公司合作，产品出口意大利、泰国、新加坡、台湾等国家。

苏鑫管夹始终把“专业化、标准化、国际化”作为公司经营发展的生命线，坚持“以顾客关注为焦点”，秉承“精益求精，持续改进，微利经营，合作双赢”的经营理念，为各种工业液压提供优质及具竞争性的产品和服务。

**公司热忱欢迎您来电来函咨询，并随时恭候您来公司考察、指导。**

Jiangsu Susen Clamps Manufacturing Co., Ltd. (Susen Clamps), located in Funing County Economic Development Zone, Jiangsu, is a company specializing in the R&D and production of hydraulic pipe fittings. With 18-years experience in pipe clamp manufacturing, Susen's products mainly include 24 series covering 6800 varieties, i.e., all series of plastic clamps, aluminum alloy clamps, steel clamps, clamps for shipping, U-clamps, high-pressure hydraulic ball valves, high-pressure hydraulic globe valves, etc. All of them conform to international standards and national heavy machinery standards. For a long time, Susen has provided high quality supporting products for metallurgy, shipbuilding, marine works, heavy machinery, construction machinery, machine tools, electric power, papermaking and hydraulic system, etc., which are very popular among the clients.

In all industrial cities, Susen Clamps symbolizes the rapid installation and clear & distinct layout of tubes and hoses, the characteristic of vibration damping and noise reduction has received great attention for its important contribution to environmental protection. Susen Clamps is also one of the most economical products on the installation of hydraulic pipelines. The application fields of Susen Clamps are almost infinite because its extremely wide product scope nearly covers the installment and fixing of tubes and hoses in all fields.

Susen Clamps has provided a great amount of supporting products to domestic large-scale iron & steel enterprises including Capital Iron & Steel Company, Liuzhou Iron & Steel Group Company, Nanjing Iron & Steel Group, Baosteel, Taiyuan Iron & Steel Corporation, Maanshan Iron & Steel Company, China First Heavy Industries and China National Erzhong Group Co. and the industries of heavy machinery, hydraulic machinery, lubrication, papermaking and so on. Susen Clamps has put its products into the international market successfully, cooperated with numerous international famous companies and exported its products to many countries and regions including Thailand, Italy, Singapore and Taiwan, etc.

Susen Clamps always believes "Professional, Standard, International" as the lifeline of corporate operation and development, persists on "Customer Focused", and upholds the operation philosophy of "striving for excellence, continuous improvement, operation with narrow profit, win-win cooperation" to provide high quality and competitive products and services to various industrial hydraulic clients.

**Susen Clamps sincerely welcomes your inquiry call or mail and looks forward to your visit and guidance.**

资质证书

INTELLIGENCE CERTIFICATE



“向客户提供可靠的  
质量和满意的服务”

Provide reliable quality and  
satisfactory service to our clients.



管夹说明 Description of Clamps	1-3
轻型系列 Light pipe clamps	4-28
双联系列 Twin pipe clamps	29-37
重型系列 Heavy pipe clamps	38-52
小型单孔管夹 Small Single-hole Pipe Clamp	53
小型双孔管夹 Small Double-holes Pipe Clamp	54
TC\TD型管子吊架 TC\TD Type pipe hanger	55
Ta型管子吊架 Ta Type pipe hanger	56
Tb型管子吊架 Tb Type pipe hanger	57
海洋工程/船用U型管夹 U-clamps for Marine Works/Shipping	58
海洋工程/船用塑料管夹 Plastic Pipe Clamps for Marine Works/Shipping	59
海洋工程/船用多管式管夹 Multi-pipe Clamps for Marine Works/Shipping	60
海洋工程/船用橡胶管夹 Rubber Pipe Clamps for Marine Works/Shipping	61
海洋工程/船用铜管管夹 Copper Pipe Clamps for Marine Works/Shipping	62
铝合金组合管夹 Combined aluminum alloy pipe clamps	63
GJ钢管夹 GJ Steel Clamp	64
钢制防震管夹 Steel Shockproof Clamps	65
槽钢防震管夹 Anti-vibration grooved steel pipe clamps	66
钢制多排管夹 Multiple steel pipe clamps	67
方钢多管径管夹 Square steel multi-pipe clamps	68-69
单管夹 Single pipe clamps	70
双管夹 Twin Pipe Clamps	71
三管夹 Triple Pipe Clamps	72
四管夹 Quad Pipe Clamps	73
单面管夹 One Side Pipe Clamp	74
U型管夹 U-form pipe clamps	75
双螺栓扁钢管夹 Flat steel pipe clamps with two bolts	76

**轻型系列** Light Series DIN 3015, Part 1



**双联双孔管夹系列** Twin Spectacle Clamp Series DIN 3015, Part 3



重型系列 Heavy Series DIN 3015, Part 2



海洋工程、船用管夹系列 Clamp Series for Marine Works/Shipping



非标系列管夹 Nonstandard Series Clamps



## 管夹说明

### Description of Clamps

#### (一) 概述 General information

##### 1、范围 Range

轻型系列管夹应用于 9 种尺寸系列的普通机械压力管子，管子外径 6-102mm。



Clamps in light series can be supplied in 9 series for pipes under normal mechanical pressure. Pipe' s o.d. ranges from 6-102mm.

双联系列管夹应用于 5 种尺寸系列的机械压力管子，管子外径 6-42mm。

Clamps in twin series can be supplied in 5 series for pipes under mechanical pressure. Pipe' s o.d. ranges from 6-42mm.

重型系列管夹应用于 11 种尺寸系列的高机械压力管子，管子外径 6-508mm。

Clamps in heavy series can be supplied in 11 series for pipes under high mechanical pressure. Pipe' s o.d. ranges from 6-508mm.

##### 2、材料特性 Material properties

特性 properties	聚丙烯 Polypropylene	尼龙 Polyamide
密度 Density	0.906g/cm <sup>2</sup>	1.12-1.15g/cm <sup>2</sup>
弯曲强度 Bending strength	36N/mm <sup>2</sup>	130...200N/mm <sup>2</sup>
冲击韧性 Impact resistance	不断 No fracture	不断 No fracture
压缩强度 Compressive strength	90N/mm <sup>2</sup>	120N/mm <sup>2</sup>
弹性模量 Modulus of elasticity	1500N/mm <sup>2</sup>	3000N/mm <sup>2</sup>
拉伸强度 Tensile stress	25-35N/mm <sup>2</sup>	80-90N/mm <sup>2</sup>
耐温 Max temperature resistance	25-35N/mm <sup>2</sup>	-40...+120°C
颜色 Color	-30...+90°C	黑 black
	绿、蓝 Green, blue	

根据要求可选用其它材料 Other materials are available upon request.

##### 3、订货代号 Order code

管夹	Pipe clamp	SX	L	P	G	1-3	20
系列	Series						
L: 轻型系列	L: light						
T: 双联系列	T: twin						
H: 重型系列	H: heavy						
材料	Material						
P: 聚丙烯	P: Polypropylene						
N: 尼龙	N: Polyamide						
L: 铝合金	L: Aluminum alloy						
G: 钢制	G: Steel						
S: 塑钢	S: POM						
B: 不锈钢	B: Stainless steel						
		管外径 Pipe O.D.					
		尺寸系列 Size					
		组合 Combination					
		内表面 Interior surface					
		G: 凹槽型 G: Grooved inside					
		S: 光滑型 S: Smooth inside					

对单个零件及附件有对应的订货代号，它们根据系列代号变化而变化。  
Order code of single part and accessory varies as the serial code varies.

注：执行国标：JB/ZQ4008-97  
Note.acc to national standard:JB/ZQ4008-97



#### 4、管夹安装的推荐距离 Recommended installation distance for clamps

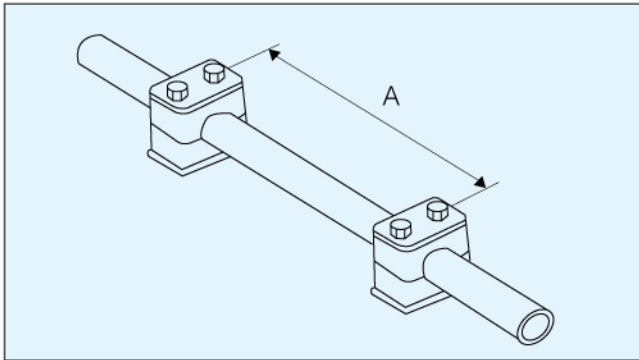

管子外径 Pipe O.D.(Mm)	管子距离 (mm) Clamp distance (mm)
6-14	0.9
15-22	1.2
23-28	1.5
30-38	2
40-48.3	2.5
50-57	3
60.3-70	3.4
73-88.9	3.7
90-108	4
114.-165.1	4.3
140-165.1	5
168.3-220	5.5

当弯头或变管处用管夹固定时，应该尽可能近地在弯管的两旁。  
When fixing the bends or the knees with clamps, make sure to fix them as close to both sides of the bend as possible.

#### 5、装配说明

##### 装配在焊接板上

装配前，为更好地确定夹的方向，建议先在固定处做好标记，后焊上焊接，嵌上管夹身的下半部分，放上需固定的管子。再放上另一半管夹身和盖板，用螺钉拧紧。

切忌直接焊接已装好管夹的底板。

##### 装地导轨上

导轨可焊在基础上，或用螺钉固定，随后将导轨螺母推入轨内，并转 90 度，将下半个管夹身嵌入螺母，放上需固定的管子，再放上上半个管夹身和盖板，用螺钉固定。

##### 叠起装配

导轨可焊在基础上，或用螺钉固定，先装上下半个管夹身，放上需固定的管子再放上上半个管夹身，用螺钉固定，通过防松盖板防止它转动。然后安装第二个管夹，方法同上。

#### 5. Assembly information

##### Assembly on welded plates

In order to determine the direction of clamps, it's recommended to mark where needs to be fixed first before assembly. Then start welding, and embed the lower half of the clamp, and set the pipes that need to be fixed. Set another half of the clamp and cover plate, and screw them with bolts.

Do not weld the base plates that have clamps installed directly.

##### Assembly on rails

Rails can be welded on the foundation, or fixed with bolts. Then push the rail nut into the rails and turn 90 °. Embed the lower half of the clamp into the nut and set the pipes that need to be fixed. Set the upper half of the clamp and cover plate, and fix them with bolts.

##### Multi-level assembly

Rails can be welded on the foundation, or fixed with bolts. Install the lower half of the clamp first, and set the pipes that need to be fixed. Then install the upper half of the clamp and fix it with bolts which must be prevented from moving with anti-loose cover plate. Then install the second the clamp with the method aforesaid.

轻型系列（按照DIN3015第1部分） Light series (acc. To DIN3015, part 1)									
尺寸系列 Size	固定用 螺栓 Bolts for fixation GB5782-86	聚丙烯 Polypropylene			尼龙6 Polyamide				
		螺栓紧固力 矩(Nm)	Bolt tightening torque (Nm)	管子夹持力 F(KN)	Clamping force F (KN)	螺栓紧固力 矩(Nm)	Tightening torque(Nm)	管子夹持力 F(KN)	Clamping force F (KN)
0	M6	8	8	0.6	0.6	10	10	0.6	0.6
1	M6	8	8	1.1	1.1	10	10	0.7	0.7
2	M6	8	8	1.3	1.3	10	10	0.8	0.8
3	M6	8	8	1.4	1.4	10	10	1.6	1.6
4	M6	8	8	1.5	1.5	10	10	1.7	1.7
5	M6	8	8	1.9	1.9	10	10	2.0	2.0
6	M6	8	8	2.0	2.0	10	10	2.5	2.5

注：执行国标：JB/ZQ4008-97  
Note.acc to national standard:JB/ZQ4008-97

## 弯管的装配 Pipe bend assembly

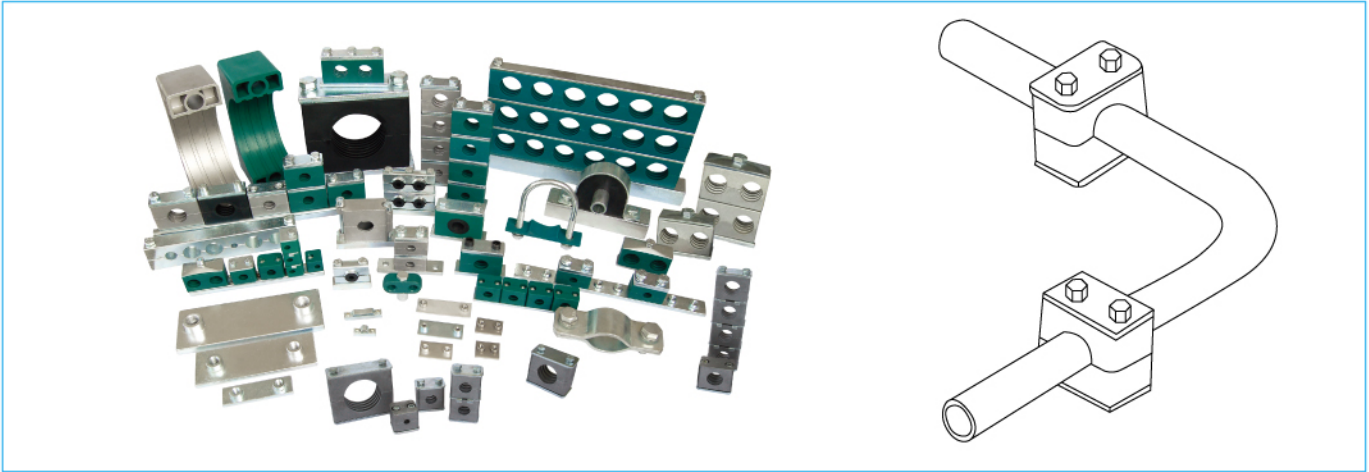

装配弯管时，应直接在弯管的前部和后部用苏鑫管夹固定。建议这样的支承点为固定位置。  
Pipe bends shall be fixed with Susen clamps in the front and in the back directly before assembly. It's recommended that such bearing point shall be the fixed position.

重型系列 (按照DIN3015第2部分) Heavy series(acc.to DIN3015,part 2)

尺寸系列 Size	固定用螺栓 Hexagon head bolt GB5782-86	聚丙烯 Polypropylene		尼龙6 Polyamide	
		螺栓紧固力矩 (Nm) Bolt tightening torque (Nm)	管子夹持力F(kN) Clamping force F (kN)	螺栓紧固力矩 (Nm) Bolt tightening torque (Nm)	管子夹持力F(kN) Clamping force F (kN)
1	M10	12	1.6	20	4.2
2		12	2.9	20	4.5
3		15	3.3	25	5.1
4	M12	30	8.2	40	9.3
5	M16	45	11.0	55	21.0
6	M20	80	14.0	150	25.8
7	M24	110	28.0	200	32.0
8	M30	180	40.0	350	48.0

## 螺栓的紧固力矩和管上的轴向夹持力 Bolt Tightening Force and Axial Clamping Force on Pipes

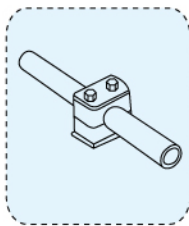

管上的轴向夹持力 (根据 DIN3015 第 10 部分) 是一个平均值, 它是由 3 次试验值计算出来的。试验时用一根按照 DIN2448 的 st37 号钢管, 温度为 23°C, 管上有静摩擦。管夹在管子的轴向上受到一个列出的测试力 (F) 时, 管夹内的管子不会滑动。

The axial clamping force on pipes (according to DIN3015, part 10) is an average value, which is obtained by three experimental values. An st37 steel pipe in accordance with DIN2448 is used for the experiment which is at 23°C and has static friction. When the clamp is under a testing force (F) listed at the axial direction, the pipe inside the clamp won't slide.

双联系列(按照DIN3015第3部分)Twin series (acc. to DIN3015, part 3)

尺寸系列 Size	固定用 螺栓 Bolts for fixation	聚丙烯 Polypropylene		尼龙6 Polyamide	
		螺栓紧固力矩(Nm) Bolt tightening torque (Nm)	管子夹持力F(kN) Clamping force F (kN)	螺栓紧固力矩(Nm) Bolt tightening torque (Nm)	管子夹持力F(kN) Clamping force F (kN)
1	GB5782-86	5	0.9	5	0.9
2	M6	12	2.1	12	2.2
3	M8	12	1.9	12	2.0
4		12	2.7	12	2.9
5		8	1.7	8	2.5

注: 执行国标: JB/ZQ4008-97  
Note.acc to national standard:JB/ZQ4008-97

执行国标 ( A cc.to national standard ) :JB/ZQ4008-2006

轻型管夹 Light pipe clamps

Lo系列单螺栓固定式 Lo series with single bolt

**轻型管夹：** 本产品适用于冶金、石油、化工、车辆、船舶、电力等机械液压系统中的油、水、气为介质的固定管道管夹。轻型系列管夹适用于中压、低压 ( PN≤8MPa ) 管道固定。

**Light pipe clamps:** This type of products is applicable for fixed pipes having oil, water and gas as media of mechanical hydraulic systems in fields like metallurgy, petroleum, chemical industry, automobile, shipping, and electricity. Light series is applicable for fixing MP and LP pipes (PN≤8MPa).

- 1、SXLPG\*– 工程聚丙烯型内孔凹槽型管夹 **工作温度 -30~+90°C**
- 1、SXLPG\*\_Engineering polypropylene grooved inside light pipe clamps, **work temperature -30 ~ +90°C**
- 2、SXLPS\*– 工程聚丙烯轻型内孔光滑型管夹 **工作温度 -30~+90°C**
- 2、SXLPS\*\_Engineering polypropylene smooth inside light pipe clamps, **work temperature -30 ~ +90°C**
- 3、SXLNG\*– 增强尼龙轻型内孔凹槽型管夹 **工作温度 -40~+120°C**
- 3、SXLNG\*\_Reinforced polyamide grooved inside light pipe clamps, **work temperature -40 ~ +120°C**
- 4、SXLNS\*– 增强尼龙轻型内孔光滑型管夹 **工作温度 -40~+120°C**
- 4、SXLNS\*\_Reinforced polyamide smooth inside light pipe clamps, **work temperature -40 ~ +120°C**
- 5、SXLLG\*– 铝合金轻型内孔凹槽型管夹 **工作温度 -50~+300°C**
- 5、SXLLG\*\_Aluminum alloy grooved inside light pipe clamps, **work temperature -50 ~ +300°C**
- 6、SXLGG\*– 钢制轻型内孔凹槽型管夹 **工作温度 -80~+500°C**
- 6、SXLGG\*\_Steel grooved inside light pipe clamps, **work temperature -80 ~ +500°C**
- 7、SXLBG\*– 不锈钢轻型内孔凹槽型管夹 **工作温度 -80~+500°C**
- 7、SXLBG\*\_Stainless steel grooved inside light pipe clamps, **work temperature -80 ~ +500°C**

说明：1、盖板、焊接底板、导轨、导轨螺母、螺栓标准材料为碳钢，根据客户需要可选用其它材料。  
请在订货时说明。

Note: 1. Standard material of cover plates, welded base plates, rails, rail nuts, and bolts is carbon steel. Other materials are available upon customer' s request which needs to be expressed by ordering.

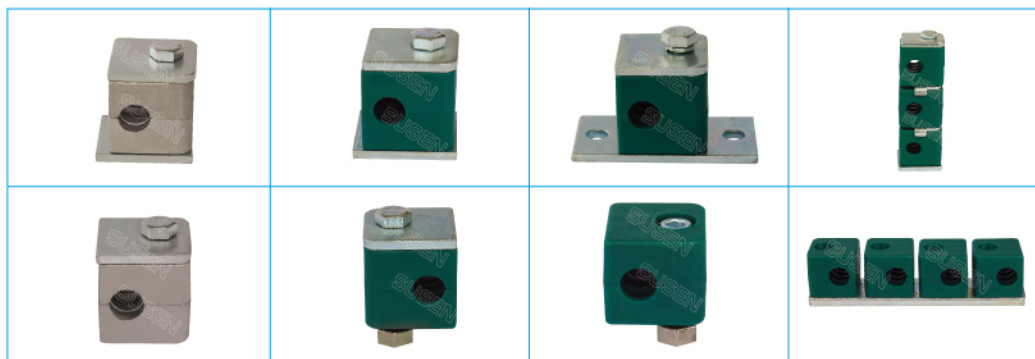

如使用不同的形式或其它要求请在订货时说明  
Other forms or requirements need to be expressed by ordering.

符合德标: DIN3015 I  
Acc. to German standard: DIN3015 I

执行国标 ( A cc.to national standard ) :JB/ZQ4008-2006

**SXL\*G1轻型管夹** SXL\*G1 light pipe clamps

开槽螺栓+管夹体+焊接底板 Grooved bolt + clamp body + welded base plate

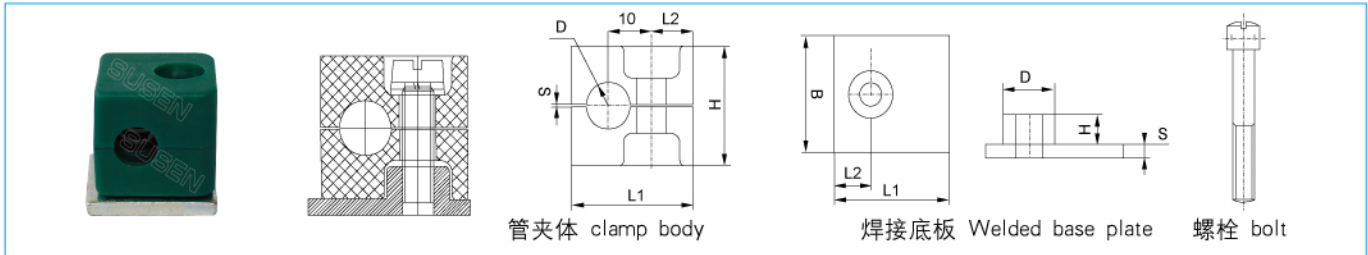

系列 Series	订货号 Order code	管外径 Pipe O.D.	英寸内径 I.D., inch	英寸外径 Inch O.D.	管夹体 Clamp body					焊接底板 Welded base plate						螺栓 bolt	
					L1	L2	H	D	S	宽度 width	L1	L2	H	D	S		B
L0	SXL*G1-006	6			28	9.5	27	φ 6	0.4	30	31	10	6.5	12	3	30	M6 × 20
	SXL*G1-006.4	6.4		1/4				φ 6.4									
	SXL*G1-008	8		5/16				φ 8									
	SXL*G1-009.5	9.5		3/8				φ 9.5									
	SXL*G1-010	10	1/8					φ 10									
	SXL*G1-012	12						φ 12									

**SXL\*G2轻型管夹** SXL\*G2 light pipe clamps

内六角螺栓+管夹体+焊接底板 Hexagon socket bolt+clamp body+Welded base plate

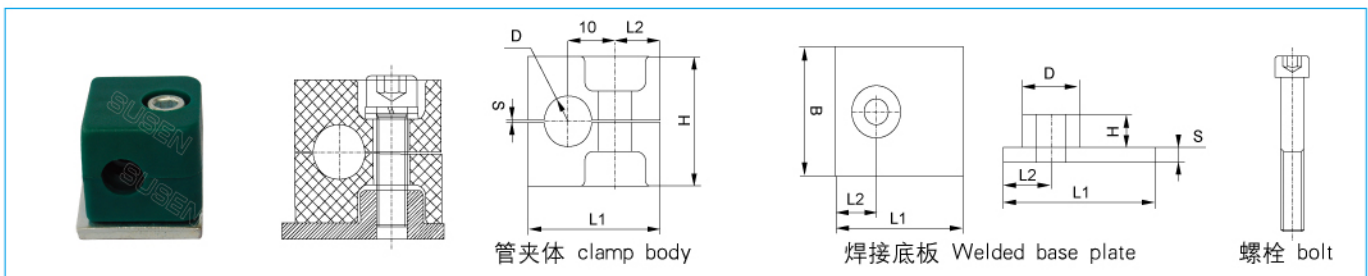

系列 Series	订货号 Order code	管外径 Pipe O.D.	英寸内径 I.D., inch	英寸外径 Inch O.D.	管夹体 Clamp body					焊接底板 Welded base plate						螺栓 bolt	
					L1	L2	H	D	S	宽度 width	L1	L2	H	D	S		B
L0	SXL*G2-006	6			28	9.5	27	φ 6	0.4	30	31	10	6.5	12	3	30	M6 × 20
	SXL*G2-006.4	6.4		1/4				φ 6.4									
	SXL*G2-008	8		5/16				φ 8									
	SXL*G2-009.5	9.5		3/8				φ 9.5									
	SXL*G2-010	10	1/8					φ 10									
	SXL*G2-012	12						φ 12									

如使用不同的形式或其它要求请在订货时说明  
Other forms or requirements need to be expressed by ordering.

符合德标: DIN3015 I  
Acc. to German standard: DIN3015 I

执行国标 ( A cc.to national standard ) :JB/ZQ4008-2006

**SXL\*G3轻型管夹** SXL\*G3 light pipe clamps

外六角螺栓+管夹体+焊接底板 Hexagon head bolt+clamp body+Welded base plate

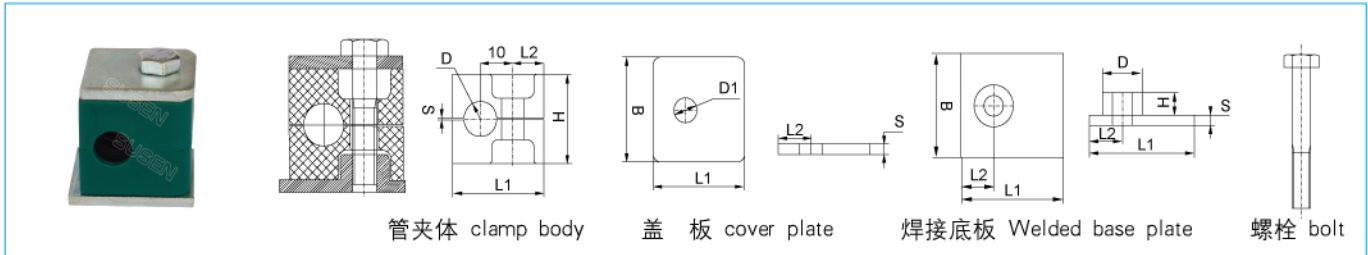

系列 Series	订货号 Order code	管外径 Pipe O.D.	英寸内径 I.D., inch	英寸外径 Inch O.D.	管夹体 Clamp body					盖板 cover plate					焊接底板 Welded base plate					螺栓 bolt		
					L1	L2	H	D	S	宽度 width	L1	L2	B	D	S	L1	L2	H	D		S	B
L0	SXL*G3-006	6			28	9.5	27	φ 6	0.4	30	28	9.5	30	7	3	31	10	6.5	12	3	30	M6 × 20
	SXL*G3-006.4	6.4	1/4	φ 6.4																		
	SXL*G3-008	8	5/16	φ 8																		
	SXL*G3-009.5	9.5	3/8	φ 9.5																		
	SXL*G3-010	10	1/8	φ 10																		
	SXL*G3-012	12		φ 12																		

**SXL\*G4轻型管夹** SXL\*G4 light pipe clamps

开槽螺栓+管夹体+长焊接底板 Grooved bolt +clamp body+long Welded base plate

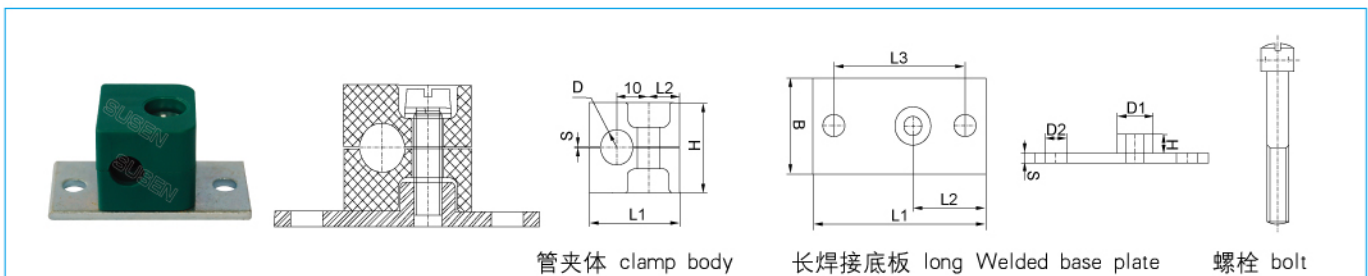

系列 Series	订货号 Order code	管外径 Pipe O.D.	英寸内径 I.D., inch	英寸外径 Inch O.D.	管夹体 Clamp body					长焊接底板 long Welded base plate							螺栓 bolt		
					L1	L2	H	D	S	宽度 width	L1	L2	L3	B	S	H		D1	D2
L0	SXL*G4-006	6			28	9.5	27	φ 6	0.4	30	58	24.5	44	30	3	6.5	12	6.5	M6 × 20
	SXL*G4-006.4	6.4	1/4	φ 6.4															
	SXL*G4-008	8	5/16	φ 8															
	SXL*G4-009.5	9.5	3/8	φ 9.5															
	SXL*G4-010	10	1/8	φ 10															
	SXL*G4-012	12		φ 12															

如使用不同的形式或其它要求请在订货时说明  
Other forms or requirements need to be expressed by ordering.

符合德标: DIN3015 I  
Acc. to German standard: DIN3015 I

执行国标 ( A cc.to national standard ) :JB/ZQ4008-2006

**SXL \*G5轻型管夹** SXL \*G5 light pipe clamps

内六角螺栓+管夹体+长焊接底板 Hexagon socket bolt + clamp body + long welded base plate

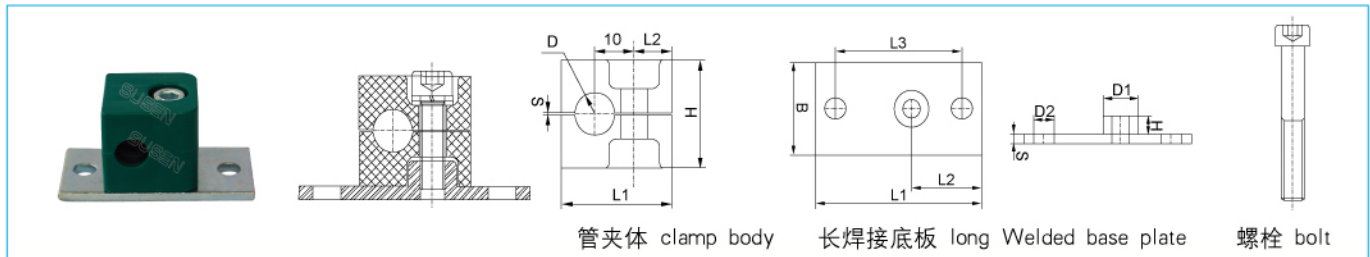

管夹体 clamp body 长焊接底板 long Welded base plate 螺栓 bolt

系列 Series	订货号 Order code	管外径 Pipe O.D.	英寸内径 I.D. inch	英寸外径 Inch O.D.	管夹体 Clamp body					长焊接底板 long Welded base plate							螺栓 bolt	
					L1	L2	H	D	S	宽 width	L1	L2	L3	B	S	H		D1
L0	SXL *G5-006	6			28	9.5	27	φ 6	0.4	30	58	24.5	44	30	3	6.5	12	M6 × 20
	SXL *G5-006.4	6.4	1/4	φ 6.4														
	SXL *G5-008	8	5/16	φ 8														
	SXL *G5-009.5	9.5	3/8	φ 9.5														
	SXL *G5-010	10	1/8	φ 10														
	SXL *G5-012	12		φ 12														

**SXL \*G6轻型管夹** SXL \*G6 light pipe clamps

外六角螺栓+盖板+管夹体+长焊接底板 Hexagon head bolt+cover plate+clamp body+long Welded base plate

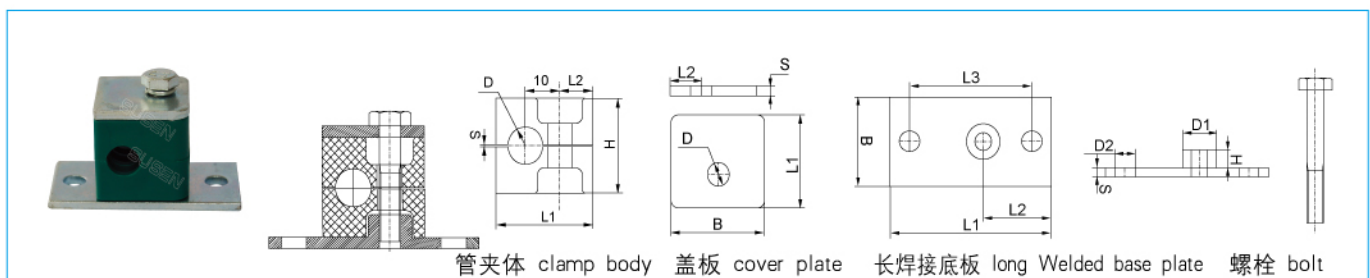

管夹体 clamp body 盖板 cover plate 长焊接底板 long Welded base plate 螺栓 bolt

系列 Series	订货号 Order code	管外径 Pipe O.D.	英寸内径 I.D. inch	英寸外径 Inch O.D.	管夹体 Clamp body					盖板 cover plate				长焊接底板 long Welded base plate							螺栓 bolt			
					L1	L2	H	D	S	宽 width	L1	L2	B	D	S	L1	L2	L3	B	S		H	D1	D2
L0	SXL *G6-006	6			28	9.5	27	φ 6	0.4	30	28	9.5	30	7	3	58	24.5	44	30	3	6.5	12	6.5	M6 × 30
	SXL *G6-006.4	6.4	1/4	φ 6.4																				
	SXL *G6-008	8	5/16	φ 8																				
	SXL *G6-009.5	9.5	3/8	φ 9.5																				
	SXL *G6-010	10	1/8	φ 10																				
	SXL *G6-012	12		φ 12																				

如使用不同的形式或其它要求在订货时说明  
Other forms or requirements need to be expressed by ordering.

符合德标: DIN3015 I  
Acc. to German standard: DIN3015 I

执行国标 ( A cc.to national standard ) :JB/ZQ4008-2006

**SXL \*G7轻型管夹** SXL \*G7 light pipe clamps

开槽螺栓+管夹体+导轨螺母 Grooved bolt + clamp body+rail nut

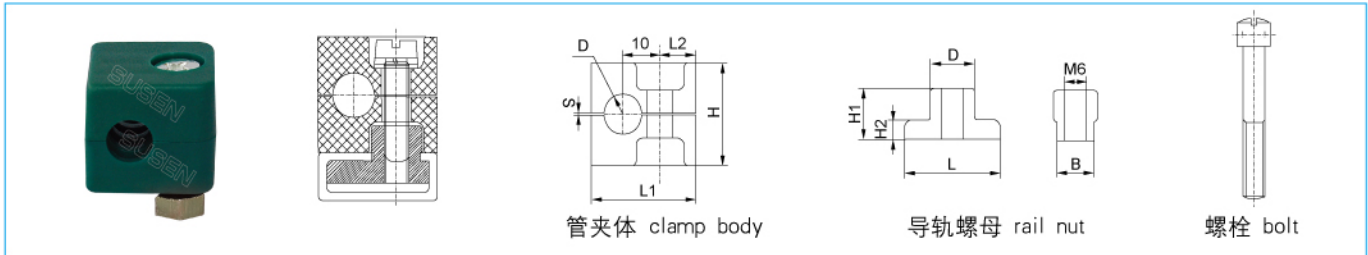

管夹体 clamp body

导轨螺母 rail nut

螺栓 bolt

系列 Series	订货号 Order code	管外径 Pipe O.D. D	英寸内径 I.D. inch	英寸外径 Inch O.D.	管夹体 Clamp body					导轨螺母 rail nut					螺栓 bolt	
					L1	L2	H	D	S	宽度 width	L	B	H1	H2		D
L0	SXL *G7-006	6			28	9.5	27	φ 6	0.4	30	25	10	13	5	12	M6 × 20
	SXL *G7-006.4	6.4		1/4				φ 6.4								
	SXL *G7-008	8		5/16				φ 8								
	SXL *G7-009.5	9.5		3/8				φ 9.5								
	SXL *G7-010	10	1/8					φ 10								
	SXL *G7-012	12						φ 12								

**SXL \*G8轻型管夹** SXL \*G8 light pipe clamps

内六角螺栓+管夹体+导轨螺母 Hexagon socket bolt + clamp body + rail nut

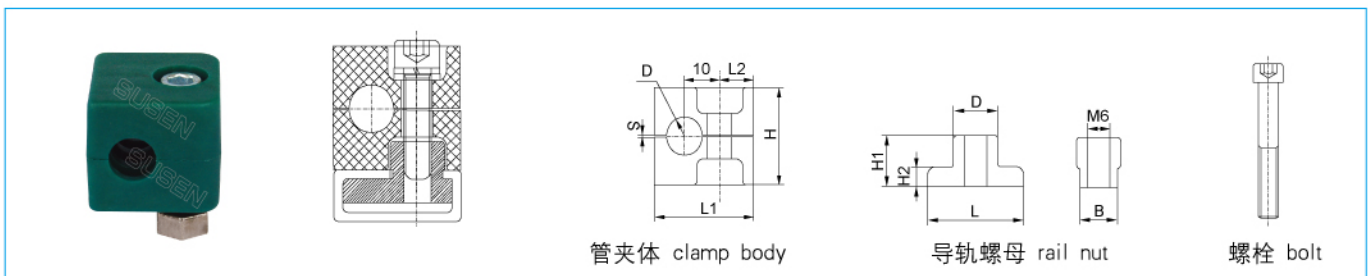

管夹体 clamp body

导轨螺母 rail nut

螺栓 bolt

系列 Series	订货号 Order code	管外径 Pipe O.D. D	英寸内径 I.D. inch	英寸外径 Inch O.D.	管夹体 Clamp body					导轨螺母 rail nut					螺栓 bolt	
					L1	L2	H	D	S	宽度 width	L	B	H1	H2		D
L0	SXL *G8-006	6			28	9.5	27	φ 6	0.4	30	25	10	13	5	12	M6 × 20
	SXL *G8-006.4	6.4		1/4				φ 6.4								
	SXL *G8-008	8		5/16				φ 8								
	SXL *G8-009.5	9.5		3/8				φ 9.5								
	SXL *G8-010	10	1/8					φ 10								
	SXL *G8-012	12						φ 12								

如使用不同的形式或其它要求请在订货时说明  
Other forms or requirements need to be expressed by ordering.

符合德标: DIN3015 I  
Acc. to German standard: DIN3015 I

执行国标 ( A cc.to national standard ) :JB/ZQ4008-2006

**SXL\*G9轻型管夹** SXL\*G9 light pipe clamps

外六角螺栓+盖板+管夹体+导轨螺母 Hexagon head bolt+cover plate+clamp body+rail nut

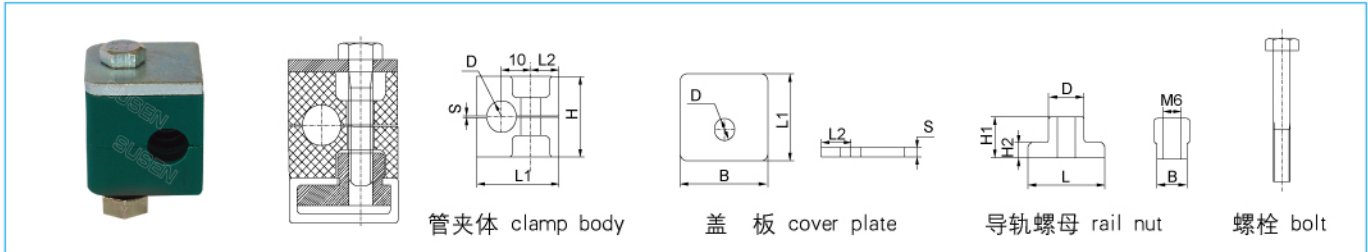

系列 Series	订货号 Order code	管外径 Pipe O.D. D	英寸内径 I.D. inch	英寸外径 Inch O.D.	管夹体 Clamp body					盖板 cover plate					导轨螺母 rail nut					螺栓 bolt	
					L1	L2	H	D	S	宽 width	L1	L2	B	D	S	L	B	H1	H2		D
L0	SXL*G9-006	6			28	9.5	27	φ6	0.4	30	28	9.8	30	7	3	25	10	13	5	12	M6 × 30
	SXL*G9-006.4	6.4	1/4	φ6.4																	
	SXL*G9-008	8	5/16	φ8																	
	SXL*G9-009.5	9.5	3/8	φ9.5																	
	SXL*G9-010	10	1/8	φ10																	
	SXL*G9-012	12		φ12																	

**SXL\*G10轻型管夹** SXL\*G10 light pipe clamps

开槽螺栓+管夹体 Grooved bolt +clamp body

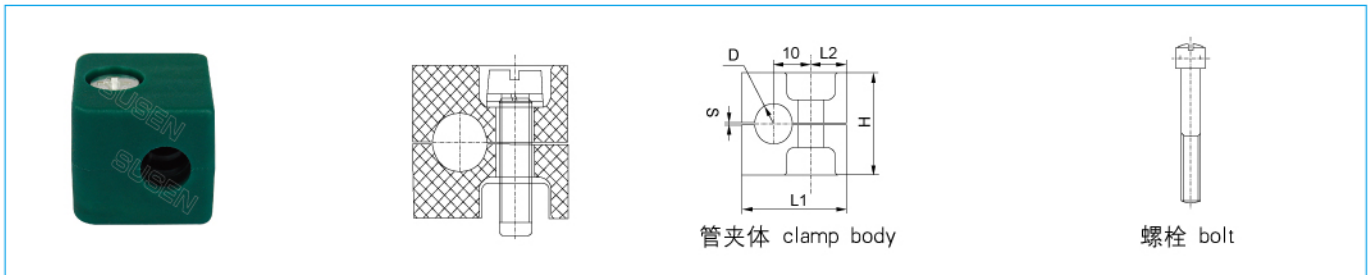

系列 Series	订货号 Order code	管外径 Pipe O.D. D	英寸内径 I.D. inch	英寸外径 Inch O.D.	管夹体 Clamp body					螺栓 bolt	
					L1	L2	H	D	S		宽 width
L0	SXL*G10-006	6			28	9.5	27	φ6	0.4	30	M6 × 20
	SXL*G10-006.4	6.4	1/4	φ6.4							
	SXL*G10-008	8	5/16	φ8							
	SXL*G10-009.5	9.5	3/8	φ9.5							
	SXL*G10-010	10	1/8	φ10							
	SXL*G10-012	12		φ12							

如使用不同的形式或其它要求在订货时说明  
Other forms or requirements need to be expressed by ordering.

符合德标: DIN3015 I  
Acc. to German standard: DIN3015 I



执行国标 ( A cc.to national standard ) :JB/ZQ4008-2006

**SXL\*G11轻型管夹** SXL\*G11 light pipe clamps

内六角螺栓+管夹体 Hexagon socket bolt + clamp body

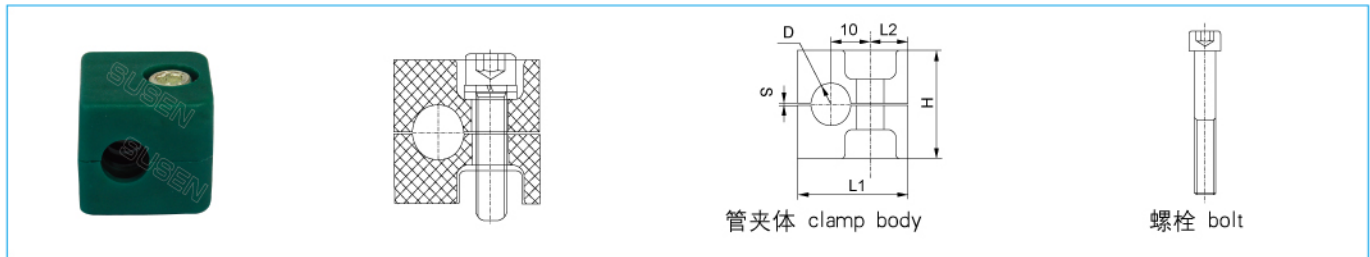

系列 Series	订货号 Order code	管外径 Pipe O.D.	英寸内径 I.D., inch	英寸外径 Inch O.D.	管夹体 Clamp body					螺栓 bolt	
					L1	L2	H	D	S		宽 width
L0	SXL*G11-006	6			28	9.5	27	φ 6	0.4	30	M6 × 20
	SXL*G11-006.4	6.4		1/4				φ 6.4			
	SXL*G11-008	8		5/16				φ 8			
	SXL*G11-009.5	9.5		3/8				φ 9.5			
	SXL*G11-010	10	1/8					φ 10			
	SXL*G11-012	12						φ 12			

**SXL\*G12轻型管夹** SXL\*G12 light pipe clamps

外六角螺栓+盖板+管夹体 Hexagon head bolt+cover plate+clamp body

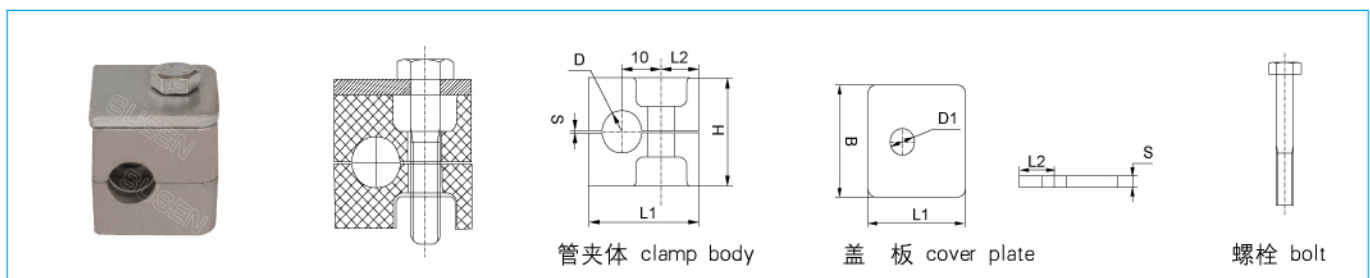

系列 Series	订货号 Order code	管外径 Pipe O.D.	英寸内径 I.D., inch	英寸外径 Inch O.D.	管夹体 Clamp body					盖板 cover plate					螺栓 bolt	
					L1	L2	H	D	S	宽 width	L1	L2	B	D		S
L0	SXL*G12-006	6			28	9.5	27	φ 6	0.4	30	28	9.5	30	7	3	M6 × 30
	SXL*G12-006.4	6.4		1/4				φ 6.4								
	SXL*G12-008	8		5/16				φ 8								
	SXL*G12-009.5	9.5		3/8				φ 9.5								
	SXL*G12-010	10	1/8					φ 10								
	SXL*G12-012	12						φ 12								

如使用不同的形式或其它要求请在订货时说明  
Other forms or requirements need to be expressed by ordering.

符合德标: DIN3015 I  
Acc. to German standard: DIN3015 I

执行国标 ( A cc.to national standard ) :JB/ZQ4008-2006

**SXL\*G13轻型管夹** SXL\*G13 light pipe clamps

长头螺栓+保险板+管夹体 Stacking bolt+safety locking plate+clamp body

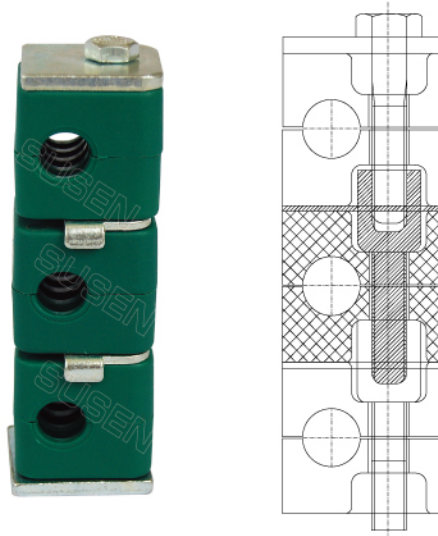

说明: 可以设计多层管夹, 最多五层  
Note: multi-layers are possible, five layers at most

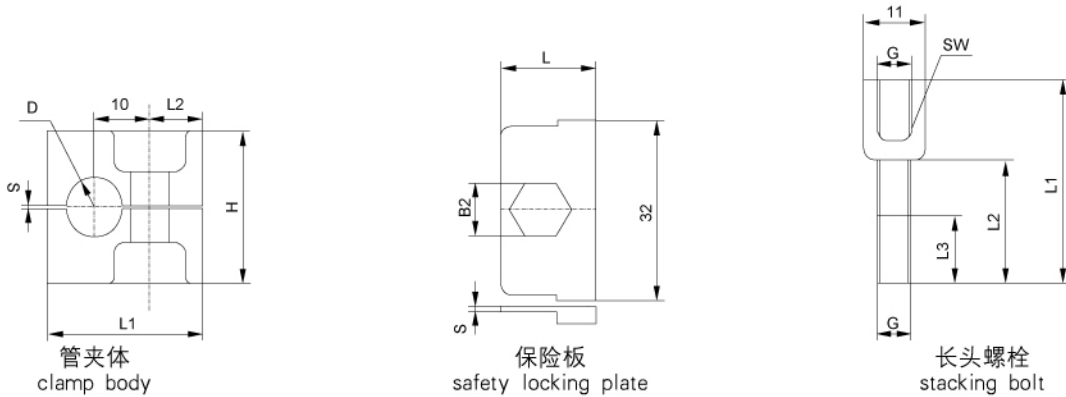

系列 Series	订货号 Order code	管外径 D O.D.	英寸内径 I.D. inch	英寸外径 Inch O.D.	管夹体 Clamp body					保险板 safety locking plate				长头螺栓 stacking bolt					
					L1	L2	H	D	S	宽 width	L	B1	B2	S	G	L1	L2	L3	SW
L0	SXL*G13-006	6			28	9.5	27	φ 6	0.4	30	17	32	11	1	M6	34	20	12	11
	SXL*G13-006.4	6.4	1/4	φ 6.4															
	SXL*G13-008	8	5/16	φ 8															
	SXL*G13-009.5	9.5	3/8	φ 9.5															
	SXL*G13-010	10	1/8	φ 10															
	SXL*G13-012	12		φ 12															

如使用不同的形式或其它要求请在订货时说明  
Other forms or requirements need to be expressed by ordering.

符合德标: DIN3015 I  
Acc. to German standard: DIN3015 I

**SXL\*G0组合轻型管夹**

**SXL\*G0 combined light pipe clamps**

**其它组合形式轻型管夹**  
**Other combined light pipe clamps**

- |  |  |
|--|--|
| 1、轻型塑料内孔凹槽型管夹                                | 5、轻型铝合金内孔凹型管夹                                      |
| 1、Plastic grooved inside light pipe clamps   | 5、Aluminum alloy grooved inside light pipe clamps  |
| 2、轻型塑料内孔光滑型管夹                                | 6、轻型塑钢内孔凹槽型管夹                                      |
| 2、Plastic smooth inside light pipe clamps    | 6、POM grooved inside light pipe clamps             |
| 3、轻型尼龙内孔凹槽型管夹                                | 7、轻型钢制内孔凹槽型管夹                                      |
| 3、Polyamide grooved inside light pipe clamps | 7、Steel grooved inside light pipe clamps           |
| 4、轻型尼龙内孔光滑型管夹                                | 8、轻型不锈钢内孔凹型管夹                                      |
| 4、Polyamide smooth inside light pipe clamps  | 8、Stainless steel grooved inside light pipe clamps |



导轨式 rail

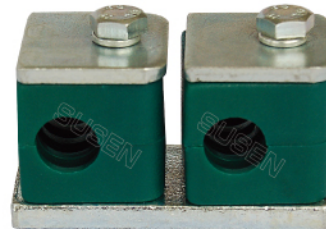

双联或多联式 twin or multiple

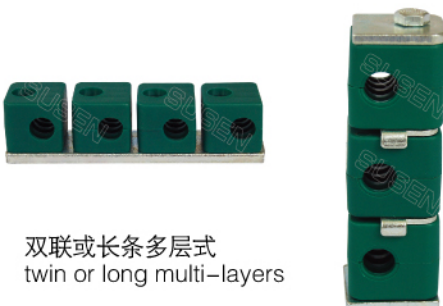

双联或长条多层式  
twin or long multi-layers



导轨式 rail

如使用不同的形式或其它要求请在订货时说明  
Other forms or requirements need to be expressed by ordering.

符合德标: DIN3015 I  
Acc. to German standard: DIN3015 I